

# USER MANUAL



PROVIDING **GLOBAL SYSTEM** SOLUTIONS

**CONTROLS**  
**A111C/A112H**

---

## TABLE OF CONTENTS

CONTENTS	PAGE
• GENERAL DESCRIPTION	2
• TERMINAL-THERMOSTAT INSTALLATION	3
• USER INTERFACE DESCRIPTION	4
• SELECTING UNIT OPERATING MODE AND SET-POINT	5
• SELECTING THE TEMPERATURE SET-POINT CATEGORY	6
• CLOCK AND TIME BANDS (AS AN OPTION)	7-8-9
• PARAMETERS, STATUS AND READINGS (PROGRAMMING)	10-11-12
• DEFROST MANAGEMENT	13
• ALARM CODES	14
• REMOTE SENSORS (AS AN OPTION)	15
• THERMOSTATIC FREECOOLING (OPTION).	16
• STANDARD GUIDELINES TO LENNOX EQUIPMENT	17

## GENERAL DESCRIPTION

This electronic control is organised into two integrated systems: a terminal, installed in the room, and a power board for managing the actuators in the electrical panel. The terminal is connected to the power board using a two-lead cable, thus greatly simplifying installation.

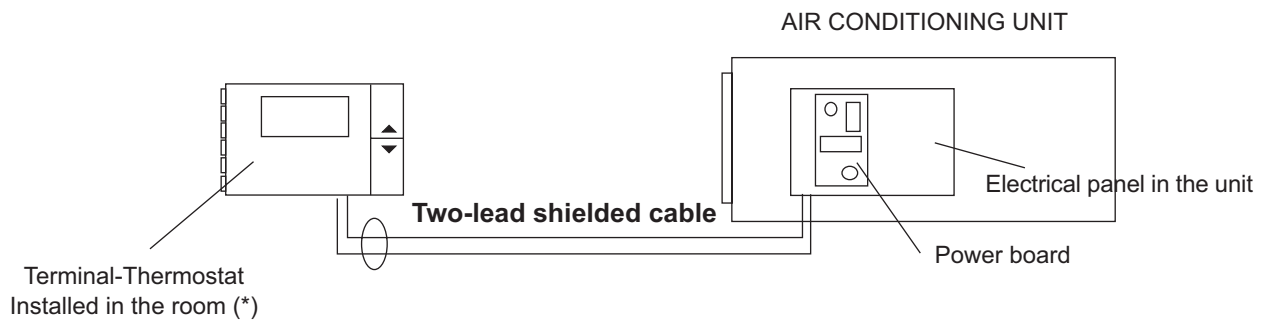

(\*)If a remote sensor is requested as an option, the terminal-thermostat can be installed in a different place from the room to be conditioned

## IMPORTANT

Since this type of control panel is factory-configured for each application, an identification code located on the control panel of the terminal itself has been given to each panel.

**Any query or request for a replacement of the control panel must be accompanied by this identification code.**

### IDENTIFICATION CODE FOR THE TERMINAL-THERMOSTAT

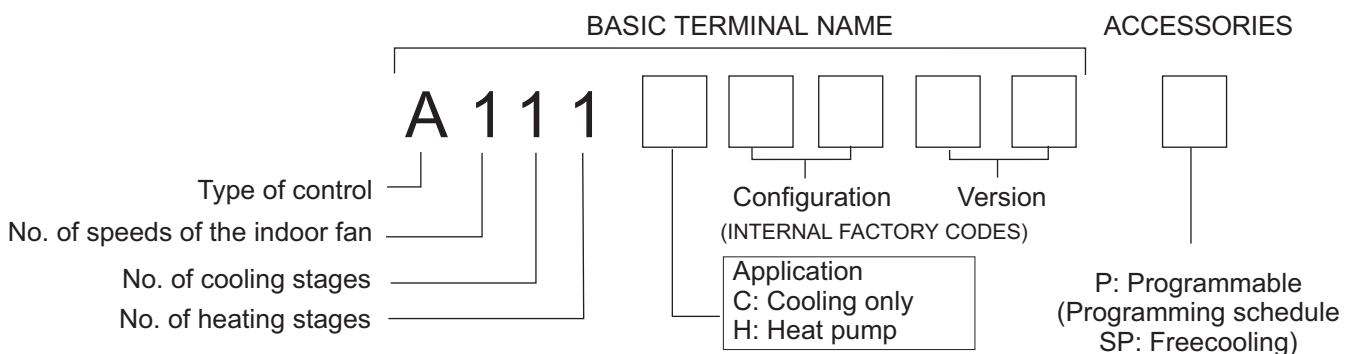

Your new LENNOX Thermostat has been designed to provide accurate control and display of room temperature. In addition, it will also display all relevant information pertaining to your system. The clearly marked buttons and informative display make it extremely easy to understand and simple to use. Please take a few moments to read the brief instructions and familiarise yourself with the various functions in order to obtain maximum benefit from this truly unique electronic control.

## TERMINAL-THERMOSTAT INSTALLATION

For correct installation the following warnings must be heeded:

- Always disconnect the power supply before performing any operations on the board during assembly, maintenance or replacement.
- The terminal should be fastened to the wall vertically, allowing for air to circulate through the instrument's vent-holes, in order to detect the correct ambient temperature.
- Avoid places where the measurement of the ambient temperature by the internal sensor may be altered, such as outside walls, near doors leading outside, in direct sunlight, etc.

### Terminal installation

The installation procedure is as following:

- 1° To detach the front panel of the terminal from the rear shell, insert a flat-head screwdriver in the slot in the centre of the bottom of the box and release the locking flap.
- 2° Raise the front panel using a "hinge" movement, using the upper edge of the instrument as the pivot and raising the lower edge.

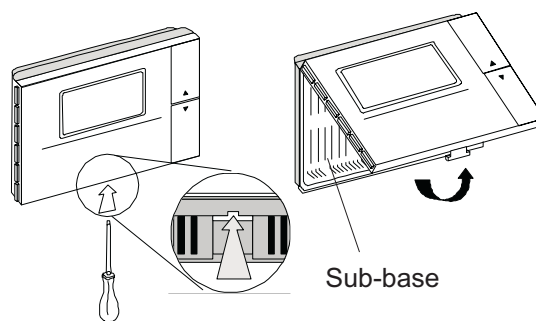

- 3° To fasten the rear part of the box to the wall, place the hole in the centre of the box over the cables for the control of the instrument which come out of the wall. The placement of the mounting holes has been designed to allow the instrument to be fixed onto a box conforming to standards CEI.431 - IEC 670. (100x600). If this is not available, use the mounting holes on the shell as a guide for drilling holes into the wall and then use the screw and plug kit supplied.

**The cables for connection to the power board must be kept separate from other cables, using an individual cable channel; and use shielded cables, with a cross-section of 1mm.<sup>2</sup>**

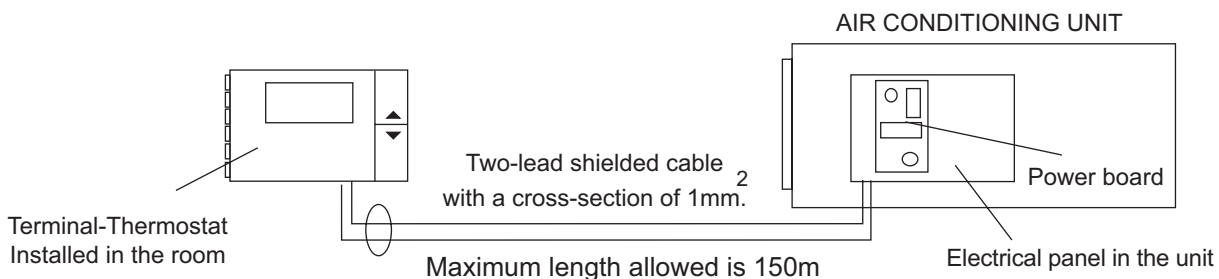

- 4° Connect the cables to the terminals on the rear shell of the box, as indicated in, and in electrical diagram.

**When making the connection to the power board, special attention must be paid to the polarity; the T+ terminal must be connected to the T+ terminal on the power board; similarly for the T- terminal (If the cables are connected in the opposite order the instrument will not be damaged).**

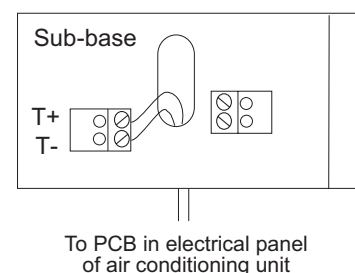

- 5° Finally, close the instrument, moving the front panel onto the rear shell with a "hinge" movement, in the opposite way as used for opening. First the long side of the front panel near the display is snapped onto the rear shell, then the opposite side, being careful that the terminal pins slide into their corresponding female terminals.

## USER INTERFACE DESCRIPTION

THE CONTROL IS ACTIVE 5 SECONDS AFTER THE UNIT POWER IS SWITCHED ON

### FUNCTIONS OF THE BUTTONS

#### ▲ AND ▼ BUTTONS

These are placed on the front panel of the instrument. These allow the immediate setting of the desired temperature (set-point), and with them the parameters could be modified.

While unit is ON:

- If both button are pressed together for one second, the display will show up the set point in place of the room temperature.
- If both button are pressed together for more than five seconds, the display will show up the software version.

#### SIDE BUTTONS

These buttons allow access to all the other functions of the control.

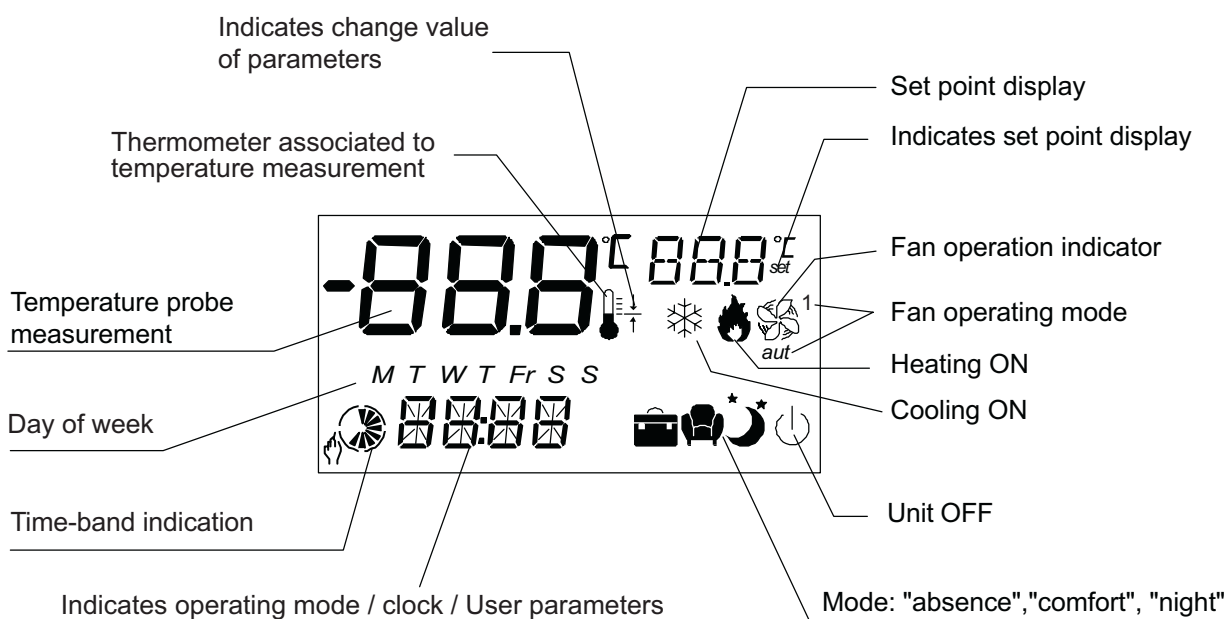
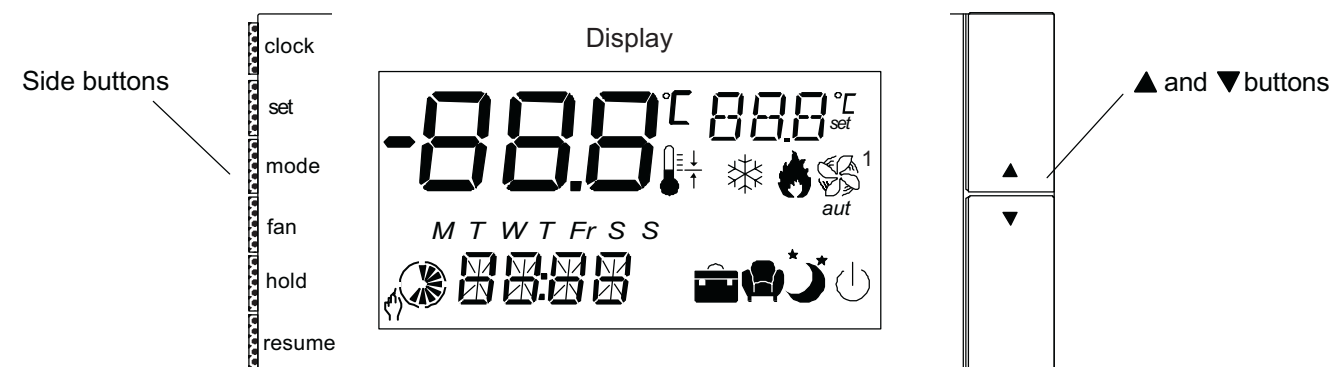

## SELECTING UNIT OPERATING MODE AND SET-POINT TEMPERATURE

### A ) SELECTING THE UNIT'S OPERATING MODE

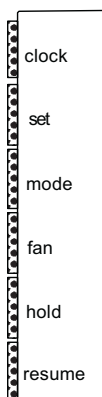

The operating mode is always indicated on the display.

Pressing the **mode** button repeatedly you can change the unit operating mode:

**COOL:** The unit is working on cooling mode, when compressor is working, the symbol  will appear on the display.

**HEAT:** The unit is working on heating mode, when compressor or electrical heater are working, the symbol  will appear on the display.

**AUTO:** The system automatically switches from cooling to heating mode, depending on the position of the ambient temperature in respect to the set-point.

**FAN:** The unit will work on fan mode; When fan is working the symbol  will appear.

**OFF:** The thermostat switches the unit off, the symbol  appears on the display .

**The operating mode selected is active 5 seconds from setting, when the respective sign stops flashing.**

### B ) SELECTING DESIRED ROOM TEMPERATURE (SET-POINT)

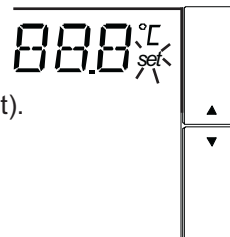

If unit is working, the **▲** or **▼** buttons allow to select the desired room temperature (set-point).

The button **▲** allows the increase of the current set-point by 0.5°C.

The button **▼** allows the decrease of the current set-point by 0.5°C.

### C ) SELECTING THE FAN OPERATING MODE

To be able to select a fan operating mode, cool, heat or auto unit's operating mode must be selected

Pressing FAN side button scrolls through the following modes: FAN CONSTANTLY ON, or AUTO

#### FAN CONSTANTLY ON

Fan is continuous ON, the symbol  will appear.

#### AUTO:

Fan on and off together with the compressor, the symbol  will appear.

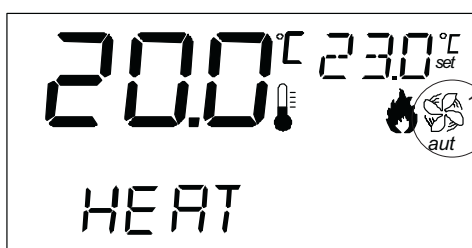

Fan operating mode

## SELECTING THE TEMPERATURE SET POINT CATEGORY

### D) SELECTING THE TEMPERATURE SET POINT CATEGORY

After COOL, HEAT or AUTO operating mode has been selected, pressing set button selects the set point category.



There are 3 possible set-point categories available

1- Comfort set-point (indicated by the symbol ):  
It is the reference room desired temperature (set-point), used for the rest of the categories.



2-Brief absence set-point (indicated by the symbol ):  
Typically used when the room is not occupied for a short period of time.





3- Night-time set-point (indicated by the symbol ):  
The room is occupied yet a lower level of comfort is required.

The default set-point values for the various categories are:

CATEGORY		SET COOL	SET HEAT
	COMFORT	Desired room temperature (set-point 23°C)	Desired room temperature (set-point 23°C)
	BRIEF	Increase 4°C the set point selected on comfort category	Decrease 4°C the set point selected on comfort category
	NIGHT	Increase 2°C the set point selected on comfort category	Decrease 2°C the set point selected on comfort category

#### How to change the desired temperature (set-point) for the different categories?

Pressing the **SET** button in manual operating mode selects comfort category . During the time the symbol is flashing, pressing the front buttons  and  changes the currently set-point used by the control. This is the set-point reference for the rest of the categories:

Following the same steps, we can select the categories: brief absence , or night , and with the  and  buttons assign the value between 0°C to 10°C for each category, which means the degrees increased or decreased from the comfort category set point.

## CLOCK AND TIME BANDS (AS AN OPTION)

This Terminal-Thermostat with clock function, is a programmable terminal (programming the time bands). With this terminal set-point desired can be set for 24 hours a day, seven days a week. This programmable operation is optional, and must be specified at the time of order.

Proceed as follow to program the time bands:

1° Set the actual time, to make once, when terminal is installed for the first time.

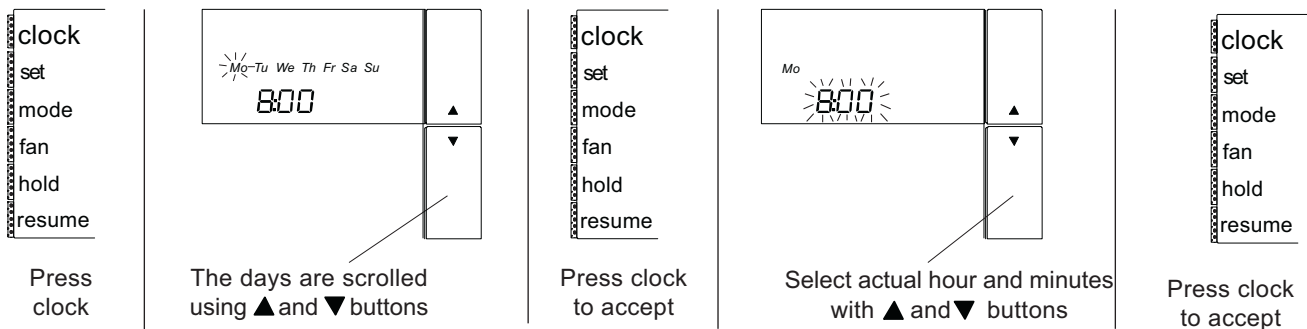

There are 6 possible time bands, indicated respectively by the letters t1-t2-t3-t4-t5-t6. The bands may be at different times for each day of the week and at different set-points, yet they must be chosen from the three categories previously programmed.

### EXAMPLE:

The table below shows an example of time bands clock for a week:

	Mo (Monday)	Tu (Tuesday)	We (Wednesday)	Th (Thursday)	Fr (Friday)	Sa (Saturday)	Su (Sunday)
t1	8:00 ☀	8:00 ☀	8:00 ☀	8:00 ☀	8:00 ☀	8:00 ☀*	8:00 ☀*
t2	14:00 ☔	14:00 ☔	14:00 ☔	14:00 ☔	14:00 ☔	22:00 ⏻	22:00 ⏻
t3	16:00 ☀	16:00 ☀	16:00 ☀	16:00 ☀	16:00 ☀	---	---
t4	18:00 ☔	18:00 ☔	18:00 ☔	18:00 ☔	18:00 ☔	---	---
t5	20:00 ☀*	20:00 ☀*	20:00 ☀*	20:00 ☀*	20:00 ☀*	---	---
t6	22:00 ⏻	22:00 ⏻	22:00 ⏻	22:00 ⏻	22:00 ⏻	---	---

Use the table below to design your own programming schedule:

	Mo (Monday)	Tu (Tuesday)	We (Wednesday)	Th (Thursday)	Fr (Friday)	Sa (Saturday)	Su (Sunday)
t1							
t2							
t3							
t4							
t5							
t6							



# CLOCK AND TIME BANDS PROGRAMMING

## PROGRAMMING PROCESS

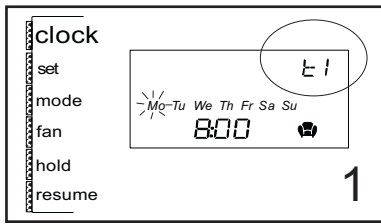

To set a program, press clock for 5 seconds, t1 will show on the display

- Mo (Monday)
- Tu (Tuesday)
- We (Wednesday)
- Th (Thursday)
- Fr (Friday)
- Sa (Saturday)
- Su (Sunday)

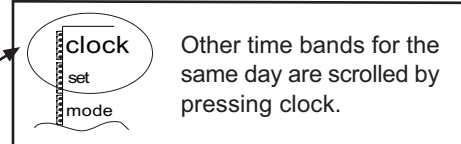
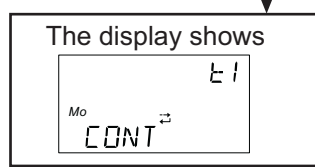
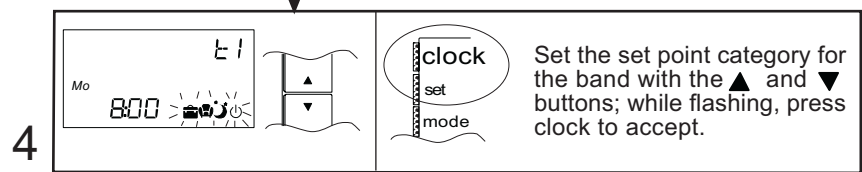
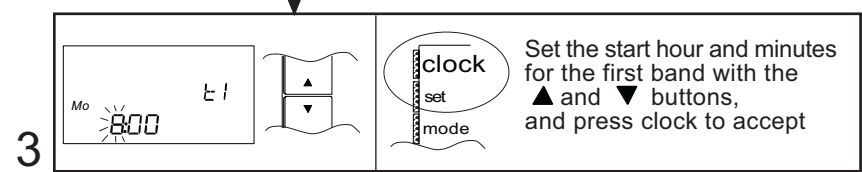
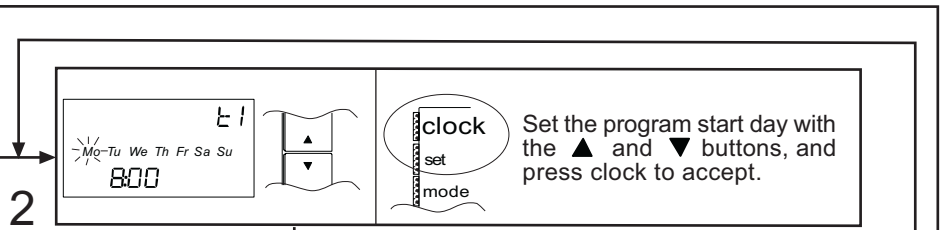

You have already programmed the 6 time band for the current day.

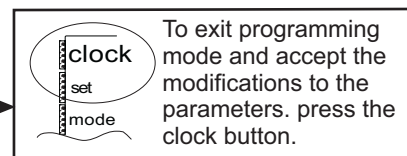
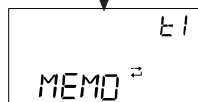
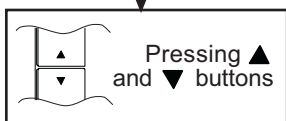
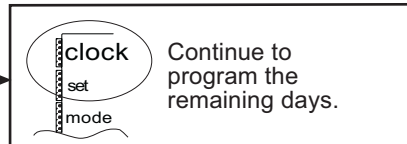
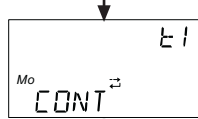
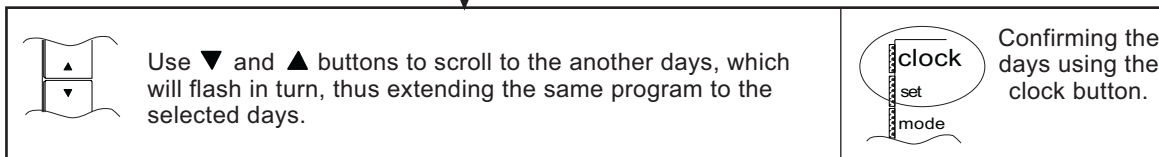
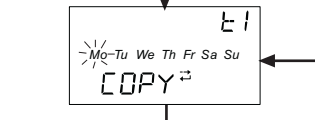
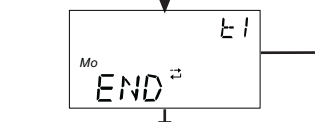
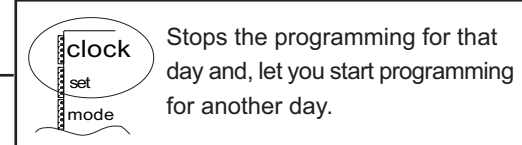
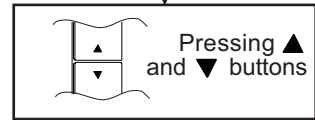

The time interval identified by time current band is shown on the display using the clock symbol, divided into 1-hour sections. Thus, the time band from 12 to 7 o'clock is indicated as follows:

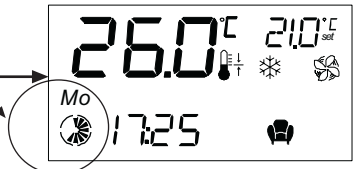

\* If you press the RESUME button, the changed will be not saved.

## CLOCK AND TIME BANDS PROGRAMMING

After all time bands have been programmed and unit is working on any of them, there are two ways to change the desired set-point for the time-band currently in use:

### A) Change the desired set-point of the current time-band for three hours.

The desired set-point can be changed, using the ▼ and ▲ buttons, and will remain for three hours. Press **resume** button to return to time band operation before the three hours elapse.

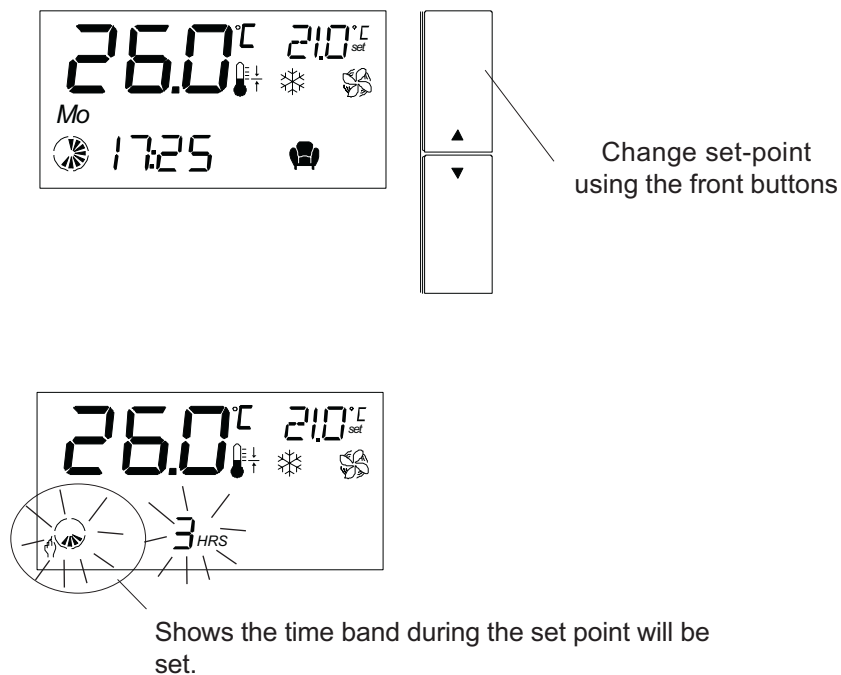

After three hours, the controller returns to the programmed settings

### B) Change the desired set-point for an unlimited period

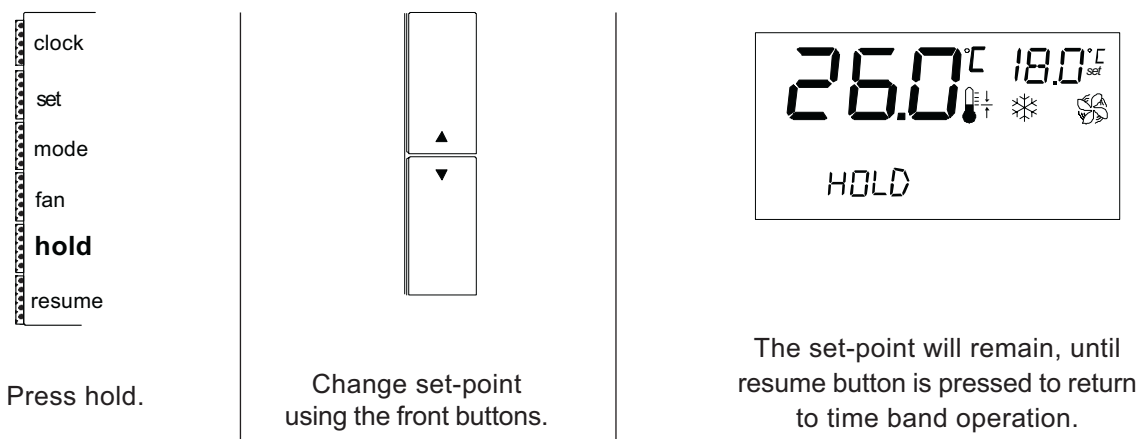

## PROGRAMMING THE PARAMETERS



All modifications on the operating unit parameters must be carried out by qualified personnel. Incorrect programming of the parameters may cause damage to the unit, And consequently the loss of guarantee of the unit.

Proceed as follow, reach to the operating parameters of the unit:

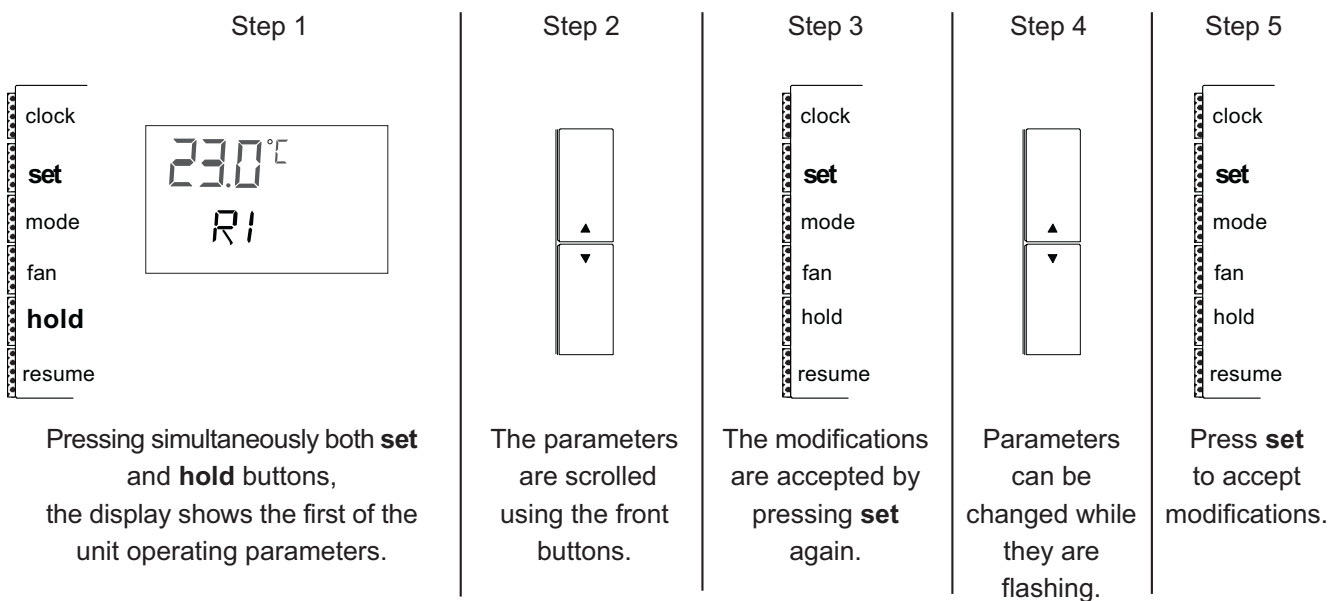

To continue modifying other operating parameters follow steps 2-3-4.

To exit programming mode and accept the modifications to the parameters, press the **hold** button.

To exit programming mode, and NOT accept the modifications to the parameters, press the resume button, or wait for 1 minute (the final 15 seconds are signalled by the flashing of the characters on the display).

## PROGRAMMING THE PARAMETERS

The table below gives the following information for each parameter.

COD: The code which appears on the display

The field variation for the parameters,

MIN: Minimum value for the parameter.

MAX: Maximum value for the parameter.

UNIT: The units of measure used.

C=Centigrade, F=Fahrenheit, s= seconds, min=minutes, h=hours, Khrs=hoursx1000

VAR.: Minimum variation allowed.

DEF: The default value, factory set.

COD	DESCRIPTION	VALUES				
		MIN	MAX	UNIT	VAR.	DEF
S4	Regulation probe calibration. Value to be added to/subtracted from the value measured by the temperature probe used for the control (sensor)	-12	12	C/F	0.5	0
S6	Input digital filter, filter for analogue inputs, S6=1 the fastest.	1	15	---	1	1
S7	Unit for temperature measure: S7=0 the temperature is visualized on °C. S7=1 the temperature is visualized °F.	0	1	---	1	0
S8	Indicates the presence of an external or internal temperature probe.	0	1	---	1	0
R1	Shows the current value on which temperature regulation is based (set-point).	---	---	C	---	23
R3	Temperature differential cool/heat.	2.0	20	C/F	0.5/1	1
R4	Temperature dead zone.	0	10	C/F	0.5/1	0,5
R8	Auxiliary element set-point offset.	0	50	C/F	0.5/1	2
R9	Auxiliary element differential.	1	22	C/F	0.5/1	1

### HOW REGULATION PARAMETERS WORK ? :

Through R1, R3, R4, R8, R9 parameters we set the temperatures for which compressor and electrical heater will turn on, as figure shows:

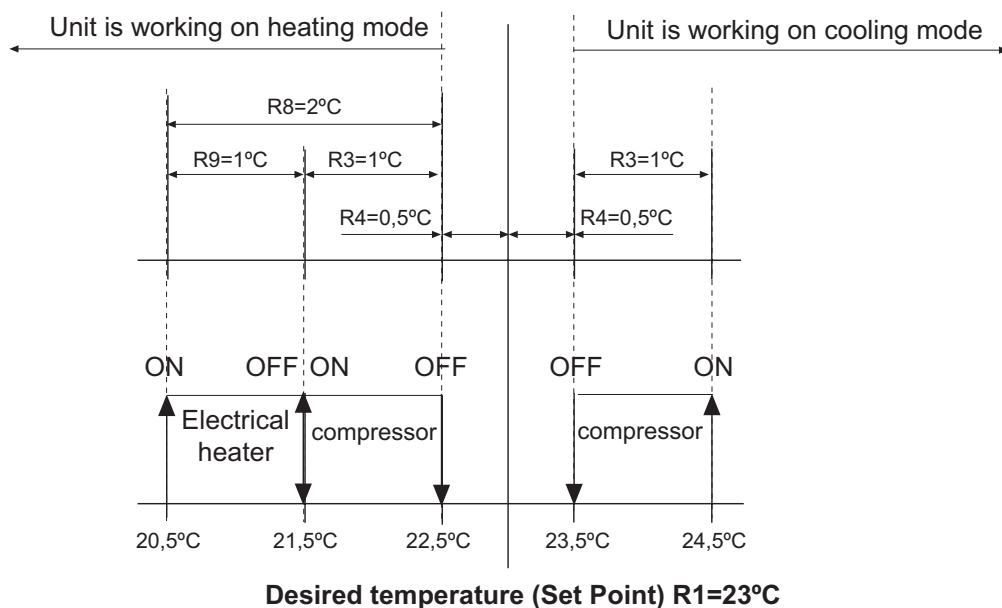

### MODIFICATION OF SET POINT VALUE

To modify the set-point value, see page 5 on this manual.

## PROGRAMMING THE PARAMETERS

COD	DESCRIPTION	VALUES		UNIT	VAR.	DEF
		MIN	MAX			
C5	Hour-counter compressor. It indicates the number of compressor operating hours. When 19.900 working hours have been reached, the parameter starts counting again .	0	19,9	Khrs	---	---
F3	Hour-counter inner fan. It indicates the number of inner fan operating hours. When 19.900 working hours have been reached, the parameter starts counting again .	0	19,9	Khrs	---	---
F4	Supply fan operating hours threshold. It establishes the number of indoor fan operating hours beyond which the maintenance intervention signal (alarm thf) is activated. F4= 0 : disables this function, alarm will not be visualized. F4=values from 1 to 10: number of hours x 1000 of indoor fan operating hours.	0	10,0	---	0,1	0

Parameters F3/F4 allow setting a number of inner fan operating hours after which the display shows the alarm code thf, which means air filter should be changed or cleaned.  
Therefore, parameter F4 should be changed, establishing the number of fan operating hours X1000 beyond which the maintenance signal thf is activated.

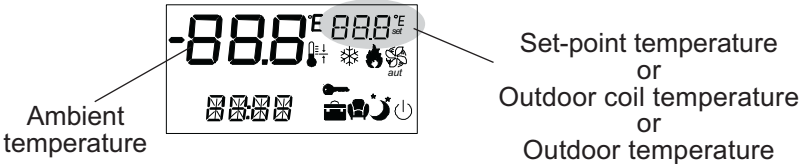
H7	It establishes what is displayed on the field in the top right of the display: H7= 0 Shows the outdoor temperature (freecooling option, heat pump). H7= 1 Shows the value of the current set-point. H7= 2 Shows the ambient and outdoor coil temperature (heat pump unit) or outdoor temperature for freecooling (cooling only).	0	2	---	---	1
						
H9	Only for terminal with clock function (as an option). It establishes the display format: H9 =0 THE FORMAT IS 24 HOUR CLOCK H9 =1 THE FORMAT IS 12 HOUR CLOCK	0	1	---	1	0

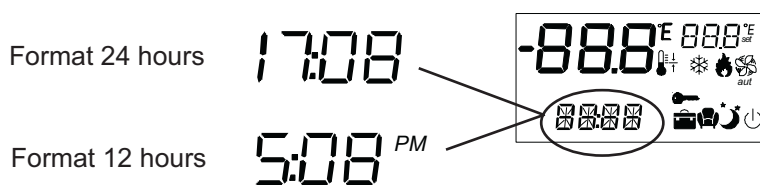

## DEFROST MANAGEMENT

The defrost process is activated during heating mode in heat pump units, when the outside temperature is low and the outdoor coil could become frozen.

To melt the ice the defrost function will switch the unit to cooling operation for a short period.

Note: During defrost function, if indoor fan is working, cold air will be supplied into the room. Using d8 parameter, the indoor fan can be switched off during the defrost process.

COD	DESCRIPTION	VALUES			UNIT	VAR.	DEF
		MIN	MAX				
d8	It establishes the enabling of the indoor fan during the defrost cycle. d8=0 Disabled (Fan off) d8=1 Enabled (Fan on)	0	1	---	1	0/1	
d13	d13=0 Normal operation for defrost function. d13=1 Force defrost function to start, defrost function will last for 10 minutes. Any time we turn on to normal operation, set d13 parameter to 0	0	1	---	1	0	

Factory setting:

If the unit is not supplied with electrical heater (option), inner fan turns on during defrost cycle after some fan time; in this case factory setting is d8=0.

If the unit is supplied with electrical heater (option), inner fan doesn't turn on during defrost cycle; in this case factory setting is d8=1.

In any case, running of electrical heater is joined with inner fan operation.

### DEFROST CYCLE SEQUENCE:

During defrost cycle, the compressor will stop for a short time, It will change the mode of working (heating mode to defrost cycle), then the outdoor fan will stop and at the end, the indoor fan will stop or not according to the parameter d8.

### START DEFROST CYCLE

The defrost cycle begins when outdoor probe temperature reaches  $-3^{\circ}\text{C}$  more than 1 minute.

### END DEFROST CYCLE

The defrost cycle ends when outdoor probe temperature reaches  $25^{\circ}\text{C}$ .

### DELAY BETWEEN TWO DEFROST REQUESTS

Time between two defrost cycles is calculated from the end of one to the beginning of next , it could be from 14 to 35 minutes, depending on external conditions.

### MAXIMUM DEFROST DURATION

10 minutes is the maximum time defrost cycle will be on.

### POWER BOARD OF THE SYSTEM AT THE ELECTRICAL BOX OF THE AIR-CONDITIONING UNIT

-The board features a signaling green LED which flashes when unit is electrically supplied.

-The control features a minimum run timer, which ensures that once started in heating or cooling, mode the compressor (and other associated components) remain running for a minimum of 5 minutes. The unit will not respond to a change in mode for this period of time. This prevents premature wear of components. Please bear this in mind when carrying out maintenance to the unit.

## ALARM CODES

The unit self-protects through safety devices, when any of these safety devices detect an anomaly, it is shown in the display in order to advise the installer.

The activation of an alarm brings about:

- The display of the alarm code and the letters "AL", alternating with the display of the temperature
- The blocking of some or all the outputs, depending on the type of alarm.

When more than one alarm is activated at the same time, the display automatically scrolls through the active alarms.



VIS (Visualization): It indicates the type of alarm shown on the display.

RE (Reset): Type of reset.

**AUT: AUTOMATIC RESET:** Some alarms are automatically reset, when the cause is no longer present, they disappear from the display.

**MAN: MANUAL RESET:** Pressing RESUME button, for more than 5 seconds or set the unit on OFF mode and then set on ON mode again.

If the alarm conditions have been removed, the instrument returns to the normal operation and the alarm relay is de-energised. If on the other hand, the alarm conditions persist, then call for technical service.

The centre of the board also houses a jumper J3, which must be set on the position shown in the electrical diagram supplied with the unit (between ID COM and INT).

When the jumper is positioned in any other position, the display shows several alarms; therefore, check this jumper when this is repeated.

VIS.	DESCRIPTION	EFFECTS	ACTION	RE
HR F	The number of operating hours of the supply fan exceeds the maintenance threshold set by parameter F4.	Alarm visualization	Air filter should be changed and reset parameter F3 (reset to 0 valve), press simultaneously the "set" button, with ▲ and ▼ front buttons	MAN
HI T	Indicates that unit is working at indoor temperatures higher than 32°C, or ambient probe is faulty.	Alarm visualization	The unit can operate in this situation only for short periods of time. If this situation remains, check or change the probe and correct hot air stratification, inlet outside cold air etc...	AUT
LO T	Indicates that unit is working at indoor temperatures lower than 10°C, or ambient probe is faulty.			
E ID	This alarm may indicate the following problems: - High pressure switch protection. - Compressor internal protection open. - Outdoor fan internal protection open.	Unit will stop	These protections are manual reset. Press the "RESUME" button for 5 seconds, until alarm disappear. If the alarm shows up again check continuity of the protections and check or change the faulty component.	MAN
th f	Indoor fan protection open or disconnected.	Unit will stop	This protection is manual reset. Press the "RESUME" button for 5 seconds, until alarm disappear. If the alarm shows up again check continuity of the protection and check or change the faulty component.	MAN
ES R	Terminal does not receive data communication from the power board.	Unit will stop	Turn off power supply and turn on again. If the problem persists, must proceed to change components. NOTE: This alarm could be caused by a faulty shielded cable connection (induction) or be too long.	AUT
ES T	Power board does not receive data communication from the terminal			
EE	EPROM error.			
E 1	Temperature regulation probe error, or connection cable broken.	Unit will stop	Check the position of jumper J1, shown on page 15, check the cable	AUT
E 2	Outdoor temperature probe error, or connection cable broken. (freecooling option, heat pump).	Unit will stop	Check the outdoor probe connection and jumpers situation according to the electrical wiring diagram.	AUT
E 3	Outdoor coil temperature probe error, or connection cable broken.	Unit will stop	Check probe connections and check the cable	AUT
E DF	The defrost process has exceeded the maximum time specified of 10 minutes and has not ended.	Alarm visualization	Exists a problem of installation (ducts) or cooling circuit (faulty refrigerant charge), the drain is obstructed, or ice has been accumulate.	AUT
L OP	Low pressure protection. After three automatic resets in one hour, becomes to be a manual reset.	Unit will stop	When the alarm shows continuously, and the alarm persists, reset with "RESUME" button. Check refrigerant charge, clean the air filters and the rotation of indoor fan.	MAN

## REMOTE SENSORS (AS AN OPTION)

As an option, there are available two types of remote sensors:

- **REMOTE DUCT SENSOR:** The sensor should be located at the return air duct , recording the room temperature continuously.
- **REMOTE AMBIENT SENSOR:** The sensor should be located at the room which has to be conditioned.

Both sensors should be used when the terminal-thermostat can be located on a position where, the room temperature could not be measured with accuracy Example: High ceiling rooms, or terminal-thermostat on a place different from the room to be conditioned.

To install them, proceed as follow:

### STEP 1:

Connect the probe to AVSS y B1 terminal located on the sub-base of the terminal-thermostat.

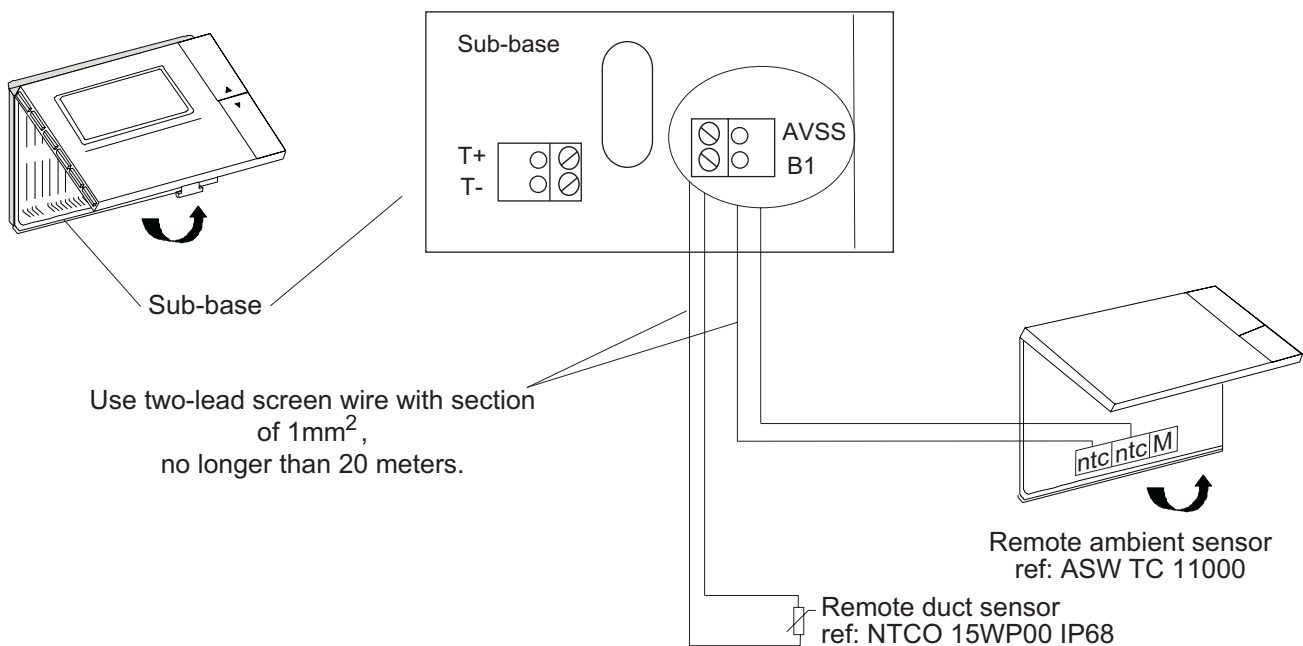

### STEP 2:

Move the jumper J1, located on the power board of the terminal-thermostat, follow the electrical diagram supplied with the unit.

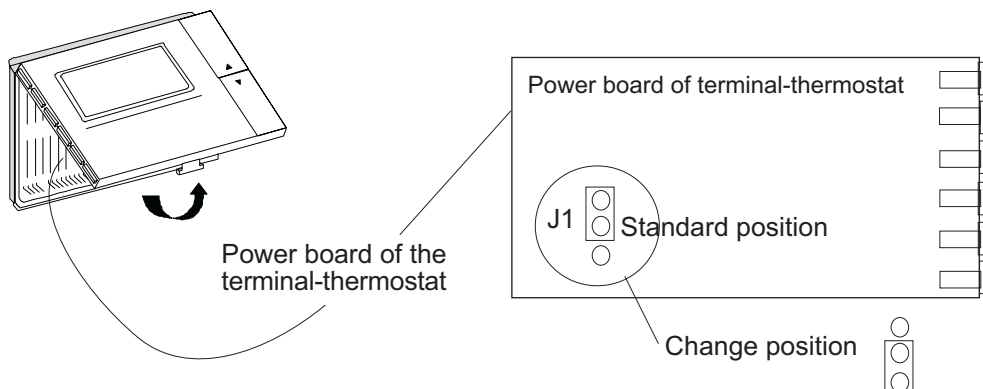

### STEP 3:

Change parameter S8 to 1.

### STEP 4:

**(Only for the optional remote duct sensor)**

Select CONT as the fan operating mode, in order that the room temperature will be detected continuously, the display shows the symbol 

See page 5 of this manual to select the fan operating mode.



## THERMOSTATIC FREECOOLING (OPTION).

Programming option is included on it. You can connect as an option remote sensors.  
To use this option an outdoor probe is connected.

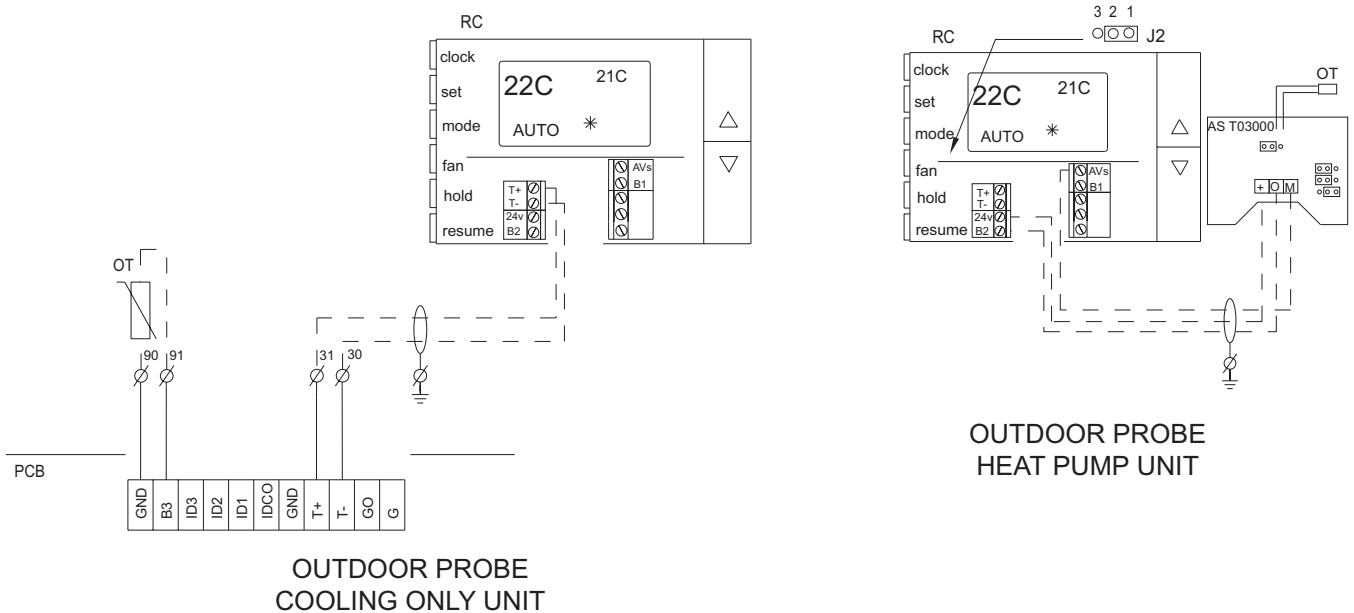

This option approaches external conditions for cooling mode.

The freecooling is enabled when outdoor temperature is below indoor temperature. For these conditions air intake gate is opened.

Two thermostats on the air discharge are incorporated for the safety of the unit:

- One of them for 4°C, closes the gate in order to prevent freezing.
- The other one for 10°C, opens the gate to take advantage from outside air.

These thermostats only work when the freecooling is enabled.

If it does not work properly, please check the jumper according to the electrical wiring diagram.

### **Standard Guidelines to Lennox Refac equipment**

All technical data contained in these operating instructions including the diagrams and technical description remains the property of Lennox Refac and may not be used (except for the purpose of familiarising the user with the equipment), reproduced, photocopied, transferred or transmitted to third parties without prior written authorisation from Lennox Refac.

The data published in the operating instructions is based on the latest information available. We reserve the right to make modifications without notice.

We reserve the right to modify our products without notice without obligation to modify previously supplied goods.

These operating instructions contain useful and important information for the smooth operation and maintenance of your equipment.

The instructions also include guidelines on how to avoid accidents and serious damage before commissioning the equipment and during its operation and how to ensure smooth and fault-free operation. Read the operating instructions carefully before starting the equipment, familiarise yourself with the equipment and handling of the installation and carefully follow the instructions. It is very important to be properly trained in handling the equipment. These operating instructions must be kept in a safe place near the equipment.

Like most equipment, the unit requires regular maintenance. This section concerns the maintenance personnel and management.

If you have any queries or would like to receive further information on any aspect relating to your equipment, do not hesitate to contact us.



**BELGIUM :**  
**LUXEMBOURG :**

**LENNOX BENELUX N.V./S.A.**  
tél. : + 32 3 633 30 45  
fax : + 32 3 633 00 89  
e-mail : info.be@lennoxbenelux.com

**CZECH REPUBLIC :**

**JANKA LENNOX a.s.**  
tél. : + 420 2 510 88 111  
fax : + 420 2 579 10 393  
e-mail : janka@janka.cz

**FRANCE :**

**LENNOX FRANCE**  
tél. : + 33 1 64 76 23 23  
fax : + 33 1 64 76 35 75  
e-mail : marketing.france@lennoxfrance.com

**GERMANY:**

**LENNOX DEUTSCHLAND GmbH**  
tél. : + 49 69 42 09 79 0  
fax : + 49 69 42 09 79 40  
e-mail : info.de@lennoxdeutschland.com

**NETHERLANDS :**

**LENNOX BENELUX B.V.**  
tél. : + 31 33 2471 800  
fax : + 31 33 2459 220  
e-mail : info@lennoxbenelux.com

**POLAND :**

**LENNOX POLSKA Sp. z o.o.**  
tél. : + 48 22 832 26 61  
fax : + 48 22 832 26 62  
e-mail : info@lennoxpolska.pl

**PORTUGAL :**

**LENNOX PORTUGAL LDA.**  
tél. : + 351 22 998 33 70  
fax : + 351 22 998 33 79  
e-mail : info@lennoxportugal.com

**RUSSIA :**

**LENNOX DISTRIBUTION MOSCOW**  
tél. : + 7 095 933 29 55  
fax : + 7 095 926 56 50  
e-mail : lennox.dist.moscow@co.ru

**SLOVAKIA :**

**LENNOX SLOVENSKO s.r.o.**  
tél. : + 421 7 44 87 19 27  
fax : + 421 7 44 88 64 72  
email : lennox.slovensko@lennox.sk

**SPAIN:**

**LENNOX REFAC S.A.**  
tél. : + 34 915 40 18 10  
fax : + 34 915 42 84 04  
e-mail : marketing@lennox-refac.com

**UKRAINE :**

**LENNOX DISTRIBUTION KIEV**  
tél. : + 380 44 461 87 75  
fax : + 380 44 461 87 75  
e-mail : lennox.ua@i.kiev.ua

**UNITED KINGDOM,  
IRELAND:**

**LENNOX INDUSTRIES Ltd**  
tél. : + 44 1604 669100  
fax : + 44 1604 669150  
e-mail : ukmarketing@lennoxind.com

**OTHER EUROPEAN COUNTRIES,  
AFRICA,  
MIDDLE-EAST :**

**LENNOX DISTRIBUTION**  
tél. : + 33 4 72 23 20 14  
fax : + 33 4 72 23 20 28  
e-mail : marketing@lennoxdist.com



**LENNOX®**

[www.lennox europe.com](http://www.lennox europe.com)